



myTEM Radio Server
MTSER-100-WL

The myTEM Radio Server is a universal, Z-Wave compatible, smart home controller. It can control various devices within the Z-Wave radio network and/or myTEM Smart Home modules via CAN bus.

The myTEM Radio Server is the heart of your intelligent home. You have access to the controller via the very simple, user-friendly myTEM Smart Home App or via the extremely powerful myTEM ProgTool. These access options allow you to assign suitable tasks and functions to all devices and to set them up for your needs. Depending on your needs, you can customize your home using predefined scenes or completely individually according to your wishes.

Further information can be found on our website:
www.mytem-smarthome.com/web/en/downloads/



ATTENTION:

This device is not a toy. Please keep it away from children and animals!

Please read the manual before attempting to install the device!

These instructions are part of the product and must remain with the end user.

Warning and safety instructions

WARNING!

This word indicates a hazard with a risk that, if not avoided, can result in death or serious injury. Work on the device must only be carried out by persons with the necessary training or instruction.

CAUTION!

This word warns of possible damage to property.

SAFETY INSTRUCTIONS

- Operate this device only as described in the manual.
- Do not operate this device if it has obvious damage.
- This device shall not be altered, modified or opened.
- This device is intended for use in buildings in a dry, dust-free location.
- This device is intended for a flat surface or for wall mounting.

DISCLAIMER

All rights reserved. This is a translation from the original version in German.

This manual may not be reproduced in any format, either in whole or in part, nor may it be duplicated or edited by electronic, mechanical or chemical means, without the written consent of the publisher.

The manufacturer, TEM AG, is not liable for any loss or damage caused by failure to follow the instructions in this manual.

Typographical and printing errors cannot be excluded. However, the information contained in this manual is reviewed on a regular basis and any necessary corrections will be implemented in the next edition. We accept no liability for technical or typographical errors or the consequences thereof. Changes may be made without prior notice as a result of technical advances. TEM AG reserves the right to make changes to product design, layout and driver revisions without notice to its users. This version of the manual supersedes all previous versions.

Installation of the myTEM Smart Home App

The myTEM Smart Home App is available for download from the Google Play Store or the Apple App Store. Select the App and install it directly from the store to your device.



The myTEM Smart Home App

You want to control the light or the temperatures in the building easily and comfortably. You want to check whether your home is in good order and that no devices consume power unnecessarily. A quick glance at your myTEM Smart Home App is enough and it lets you take appropriate steps to change something.

The myTEM Smart Home App is designed to be easy to use, to help you configure your devices and create personal "feel-good" scenes. You can also use it to monitor your power consumption and reduce it if necessary.

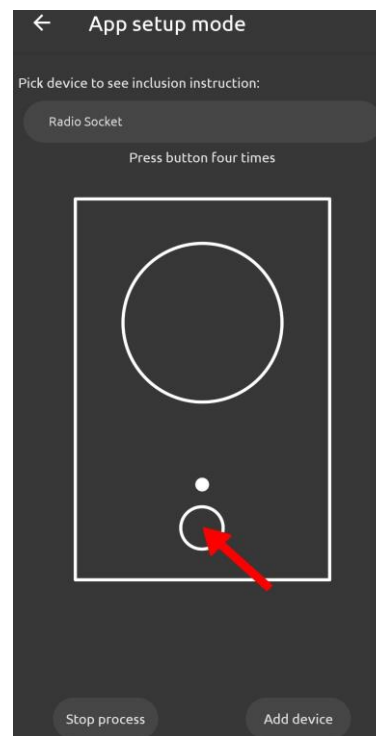

The home screen presents itself as below:

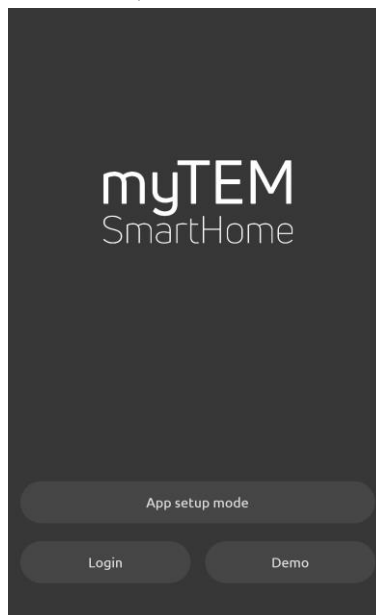

Views on the myTEM Smart Home App

Under DEMO you can access a demonstration project, where the functionality of the App is presented.

The star symbolizes the favorites view:

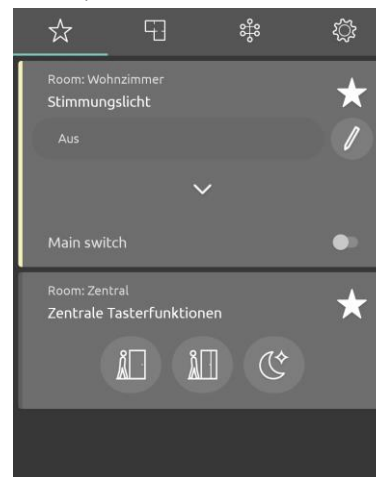

The "App setup mode" helps you to commission radio components. The required procedure is described in the wizard of the app.

The network icon shows the function view:

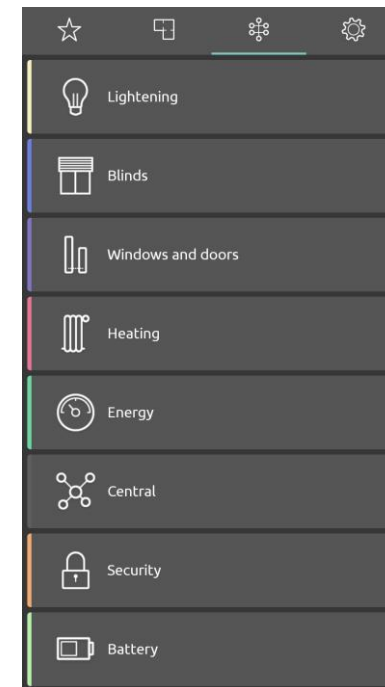

The floor plan symbol shows the room view:

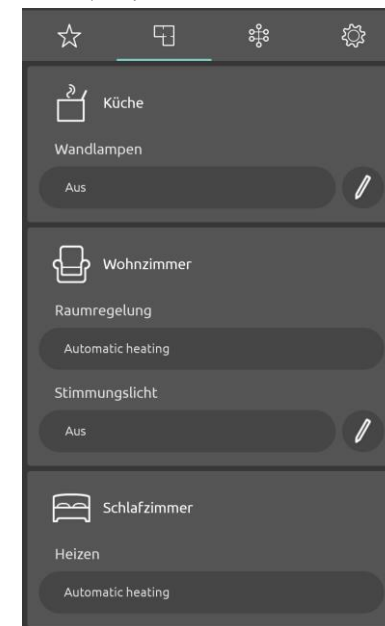

Under settings you can change the myTEM App to a bright background. Example: Bright function view:

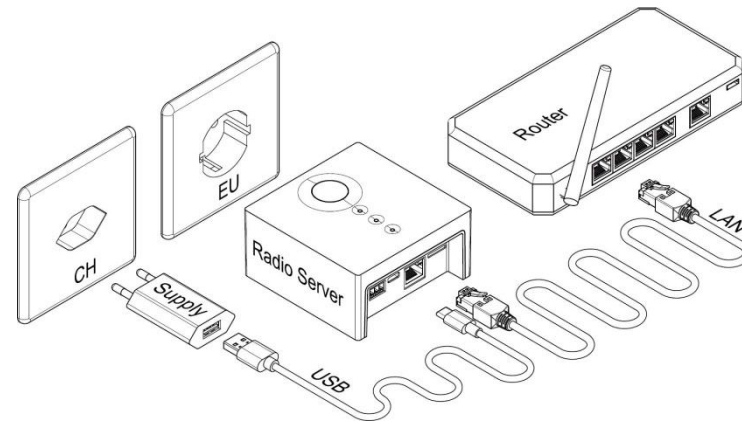
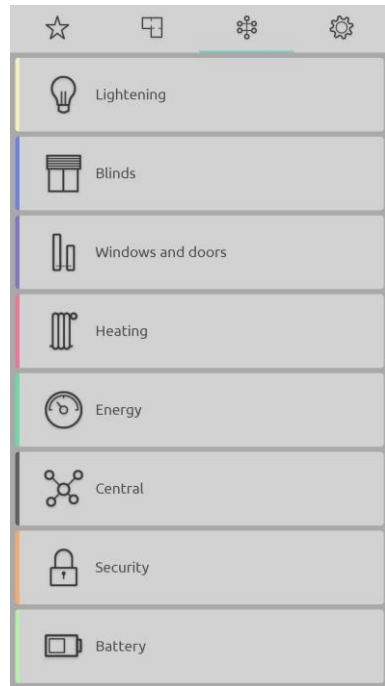

Wall mounting

The device is most often placed on a horizontal surface, but it is also possible to attach the device to a wall with the enclosed wall clip. Before you start, please check in which direction you want to lead the connection cables away, i.e. downwards, upwards or horizontal.

CAUTION! If the cables should lead upwards or downwards, the wall clip must be fastened in both cases with the lettering "TOP" upwards.

CAUTION! If the cables should lead to a side, please ensure that there is sufficient distance to obstacles so that the device can still be attached to the wall clip.

CAUTION! For wall mounting you also need two dowels with Ø5.0 mm and two screws with flat heads Ø3.0 x 25 mm as fastening material (not enclosed).

- Press the wall clip in the desired orientation/position against the wall and mark the mounting holes. Alternatively, you can mark two positions vertically or horizontally with a distance of 24 mm.
- Drill at the marked positions with Ø5.0 mm, approx. 30 mm deep and then press the dowels completely in.
- Attach the wall clip with the two screws.
- Plug the device onto the wall clip and slide it until the spring clip clicks into its place.
- Connect the cables according to chapter "Installation of the myTEM Radio Server".

Installation of the myTEM Radio Server

CAUTION! Place your device as centrally as possible in your house or apartment.

CAUTION! When planning your system, take into account the position of all devices in relation to the radio range. This is in order to avoid weak signals and sources of interference wherever possible. Weak, subdued signals can be caused by furniture, plants and especially metal objects located between devices. Possible sources of interference are electrical devices such as a microwave or computer. In this case, keep devices at least 50 cm away from the sources of interference. Ideally, create a sketch to determine the planned locations of all your devices. Install your smart home devices with increasing distance to the myTEM Radio Server.

The default user is: **admin**, the password: **123**

To install your myTEM Radio Server, please proceed as below:

1. Plug the power supply into a power outlet and connect it with the USB cable to the device.
2. Connect the device to your external wireless router with the supplied LAN cable.

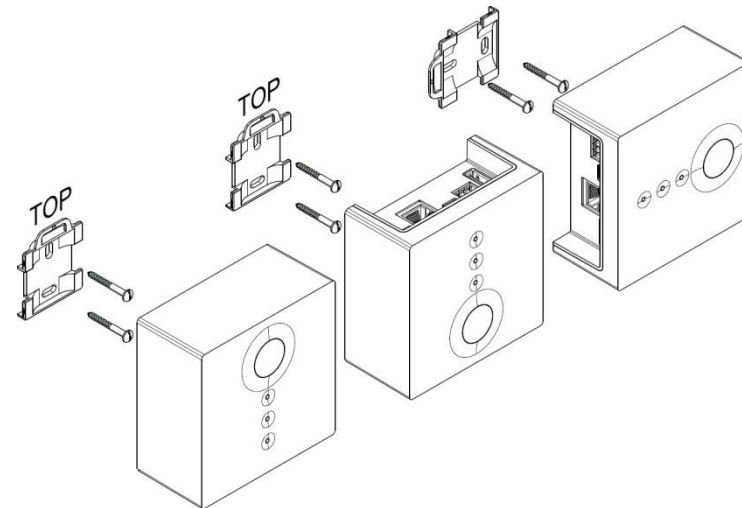

Parts of the Radio Server

- The LED's show correct power up, working LAN connection and available internet.
- The function of the button is described in a separate chapter.
- USB type C connection for 5V power supply of the device.
- USB type A connector for a WLAN stick or later extensions.
- CAN interface connection for optional access to myTEM Smart Home modules.

- LAN port for integration of the device into the local LAN network, i.e. to connect onto your router.
- Micro SD slot for data recording on a Micro SD card.
- The Z-Wave radio antenna is a non-visible, integral part of the device.

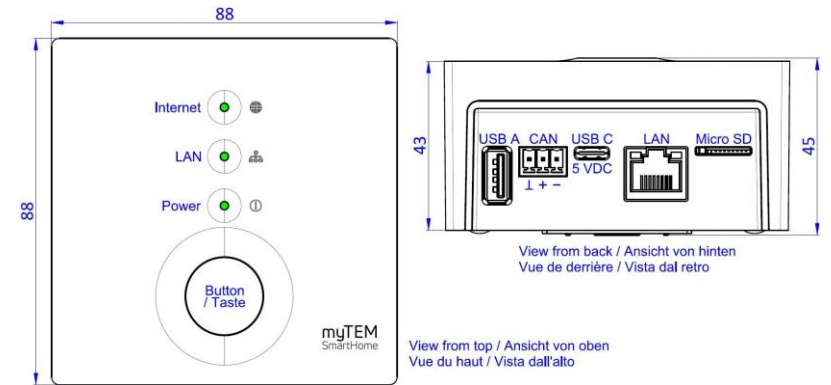

Function of the button / Reset to factory default

- Press the button briefly to switch on the device from standby.
- Press the button for 5 seconds to put the device in standby mode.
- Press the button 10x within a short time to reset the device to factory settings. The power LED flashes while the factory settings are reset and the device restarts.

CAUTION! Devices integrated via Z-Wave must be removed before the reset to factory default so they can be added to the next /a new wireless network again.

CAUTION! Resetting to factory default deletes all user-defined settings such as user, password, embedded devices, network configuration, scenes, favorites, etc.

Technical specifications

Dimensions (W x H x D)	88 x 88 x 45 mm	
Installation / mounting	On a flat surface or wall mounted	
Operating voltage USB supply	110 - 230 VAC ± 10%, 50/60Hz	
Operating voltage device	5 VDC ± 5% over USB type C connector	
Power consumption in standby	0.3 W	
Power consumption in operation	0.8 W (if USB type A connection is not used)	
Ambient temperature for operation	0 °C – 50 °C	
Ambient temperature for storage	-20 °C – 60 °C	
Ambient humidity	5 %RH – 85 %RH (non condensing)	
Wire cross-section CAN connector	0.2 mm ² – 1.5 mm ² / AWG 28 – 16	
Stripping length for connector	6.5 mm ± 0.5 mm	
Tightening torque for connector	0.2 Nm	
Protection class USB supply	II	
Overvoltage category USB supply	II	
Degree of protection of enclosure	IP 30	(according to EN 60529)
Protection class device	III	(according to EN 62368-1)
Overvoltage category device	I	(according to EN 62368-1, resp. EN 60664-1)
Pollution degree	2	(according to EN 62368-1)
Electrical safety	EN 62368-1:2014 / AC:2017	EN 62479:2010
EMC main unit	EN 55024:2010 + A1:2015	EN 55032:2015 / AC:2016
EMC radio part	EN 301 489-1 V2.1.1	EN 301 489-3 V2.1.1
Radio spectrum	EN 300 220-2 V3.2.1	
RoHS	EN IEC 63000:2018	
CE conformity	2014/35/EU (LVD) 2014/30/EU (EMC)	2014/53/EU (RED) 2011/65/EU (RoHS)
Z-Wave hardware platform	ZM5101	
Device Type	Gateway	
Role Type	Central Static Controller	